

Galle

Gall Bladder

Vésicule biliaire

VB

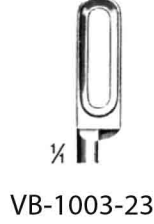
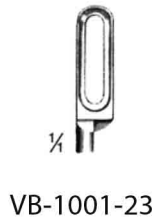
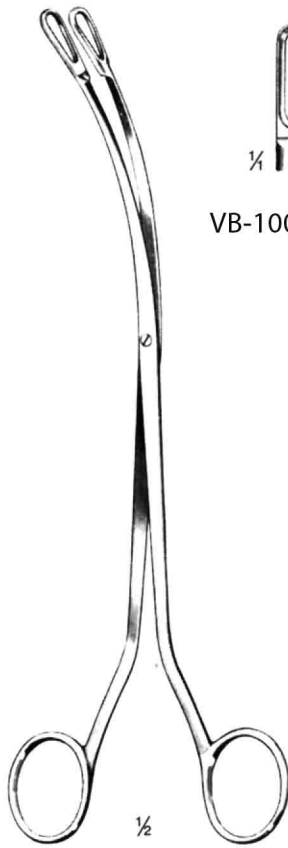

Desjardins
23cm/9.2"

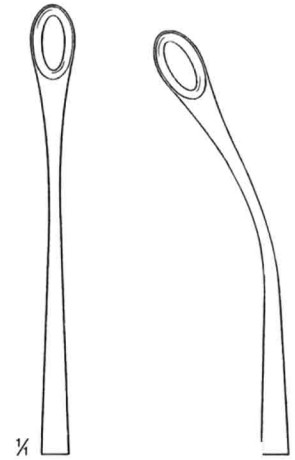
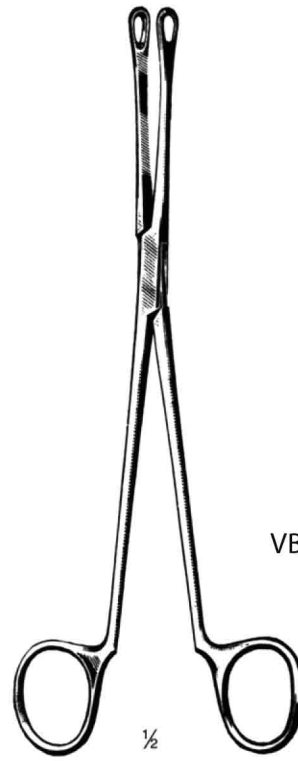

VB-1006-20 VB-1007-20
23cm/9.2"
VB-1007-23

Desjardins

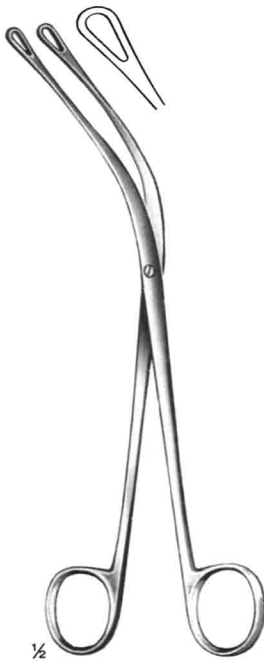

¼
Mixer
22 cm/8.8"
VB-1107-22

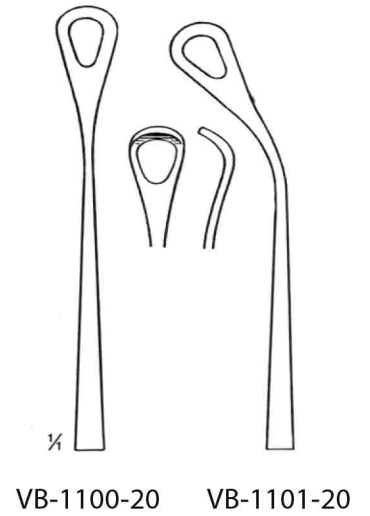
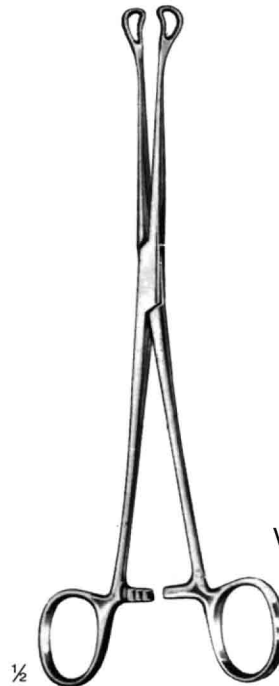

¼
Mayo-Blake
20 cm/8"

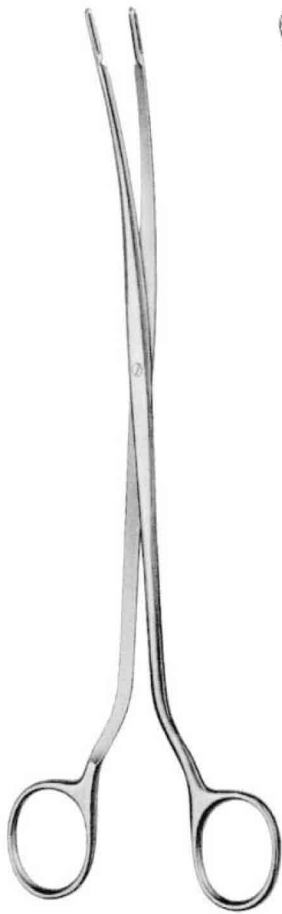

Desjardins

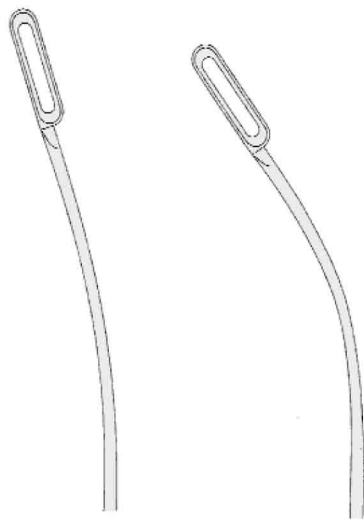

24cm/9.6"
VB-1003-24

25 cm/10"
VB-1003-25

very slender pattern

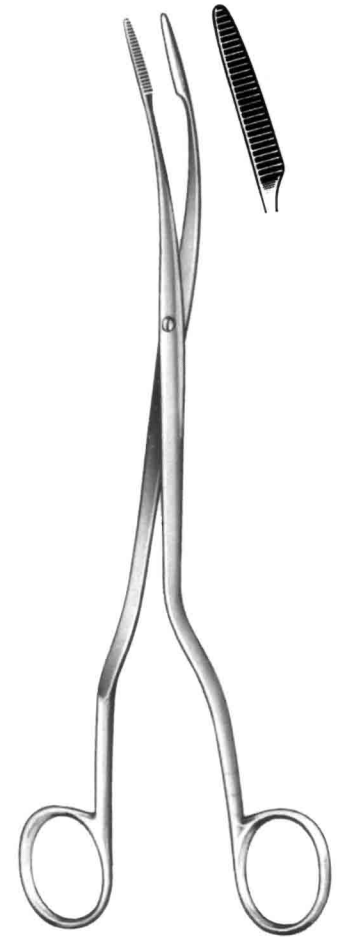

Czerny

25 cm/10"
VB-1005-25



Turner-Warwick

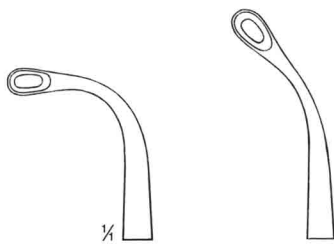

18 cm/7.2"
VB-1006-18 N

19 cm/7.6"
VB-1006-19 N

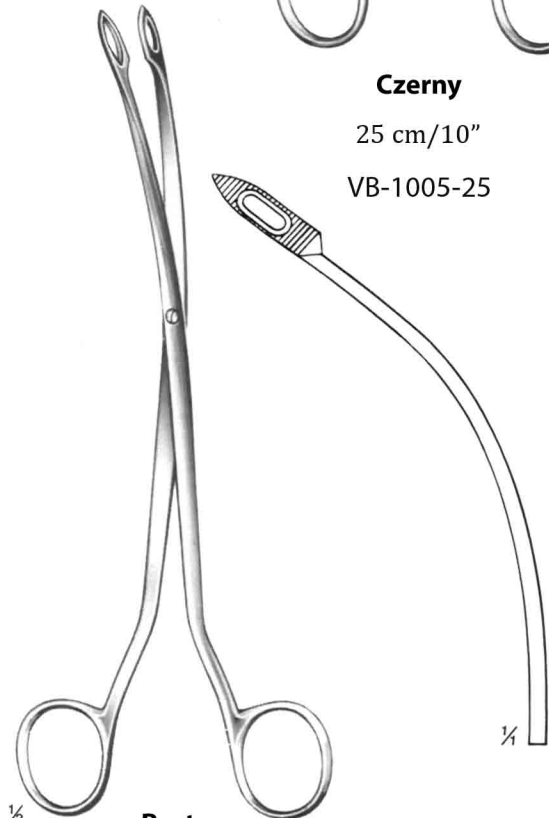

Best

22 cm/8.8"
VB-1007-22



Ochsner (Fenger)
 35 cm/14"
 VB-1208-35

Gall Duct Dilators

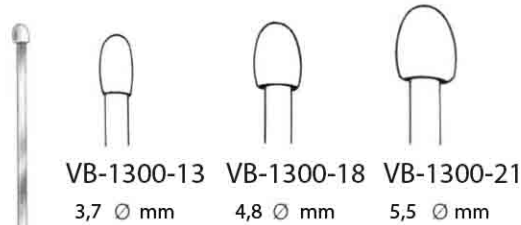

Desjardins
 28cm/11"



Moynihan
 34 cm/13.6"
 VB-1402-34

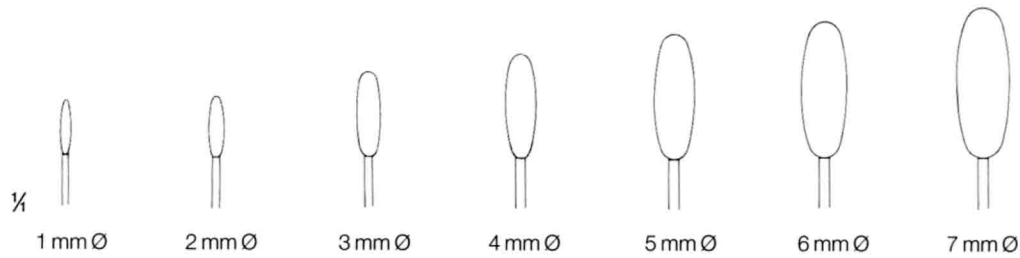

30 cm/12" VB-1500-01 VB-1500-02 VB-1500-03 VB-1500-04 VB-1500-05 VB-1500-06 VB-1500-07

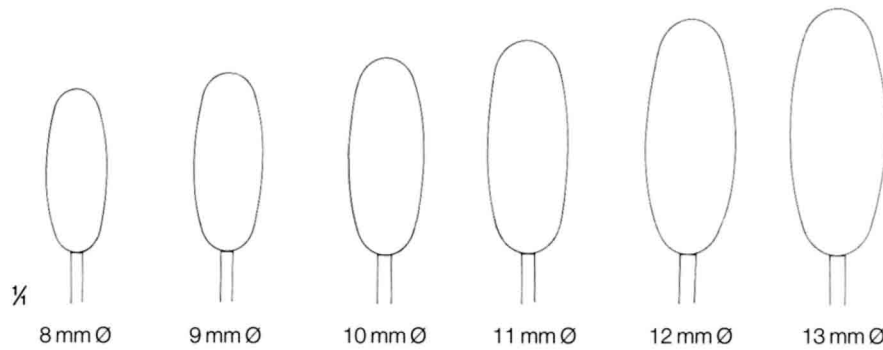

30 cm/12" VB-1500-08 VB-1500-09 VB-1500-10 VB-1500-11 VB-1500-12 VB-1500-13

Bakes

malleable shaft

21 cm/8.4"

VB-1500-00

Set of 9, consisting of 1 each 3 thru 11 mm



Mayo
26 cm/10.4"

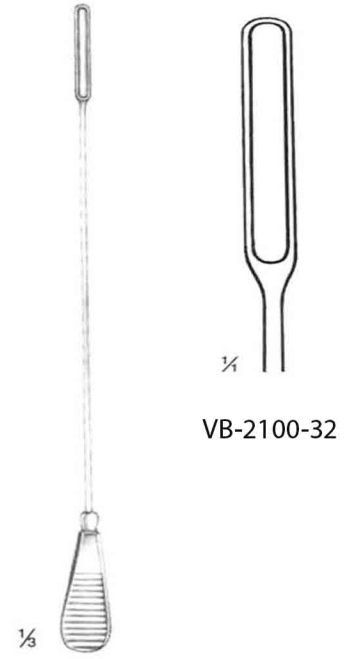
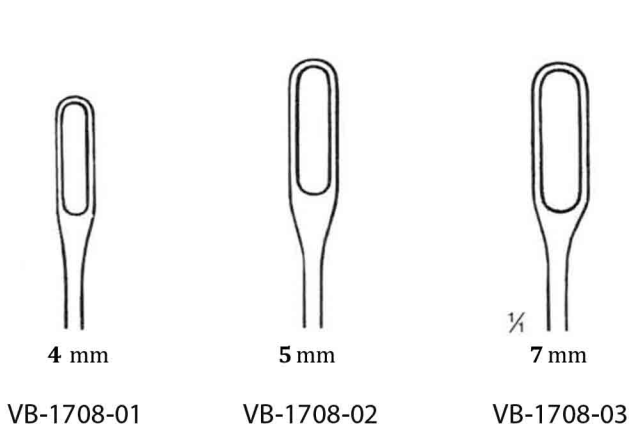

Mayo
26 cm/10.4"



Desjardins
30 cm/12"



Fergusson

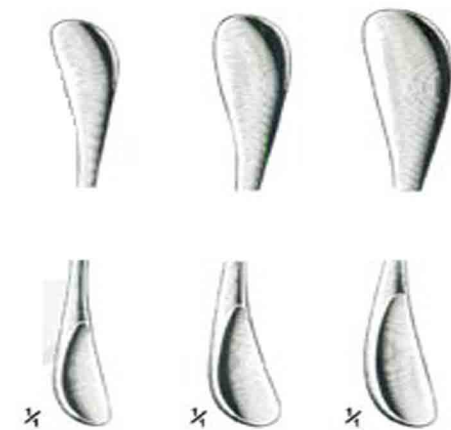

21 cm/8.4" 22 cm/8.8" 23 cm/9.2"
VB-1700-21 VB-1700-22N VB-1700-23N

Gall Stone Scoops



Luer-Körte
32 cm/12.8"
malleable, blunt



Fig. 000
VB-1810-25
2,5 mm



Fig. 00
VB-1810-32
3,2 mm



Fig. 0
VB-1810-42
4,2 mm



Fig. 1
VB-1810-55
5,5 mm



Fig. 2
VB-1810-67
6,7 mm



Fig. 3
VB-1810-80
8 mm



Fig. 4
VB-1811-10
11 mm



Fig. 5
VB-1811-50
15 mm



1/2
Mayo
28cm/11"
VB-1705-27



1/2
Moore
30 cm/12"
VB-1205-28

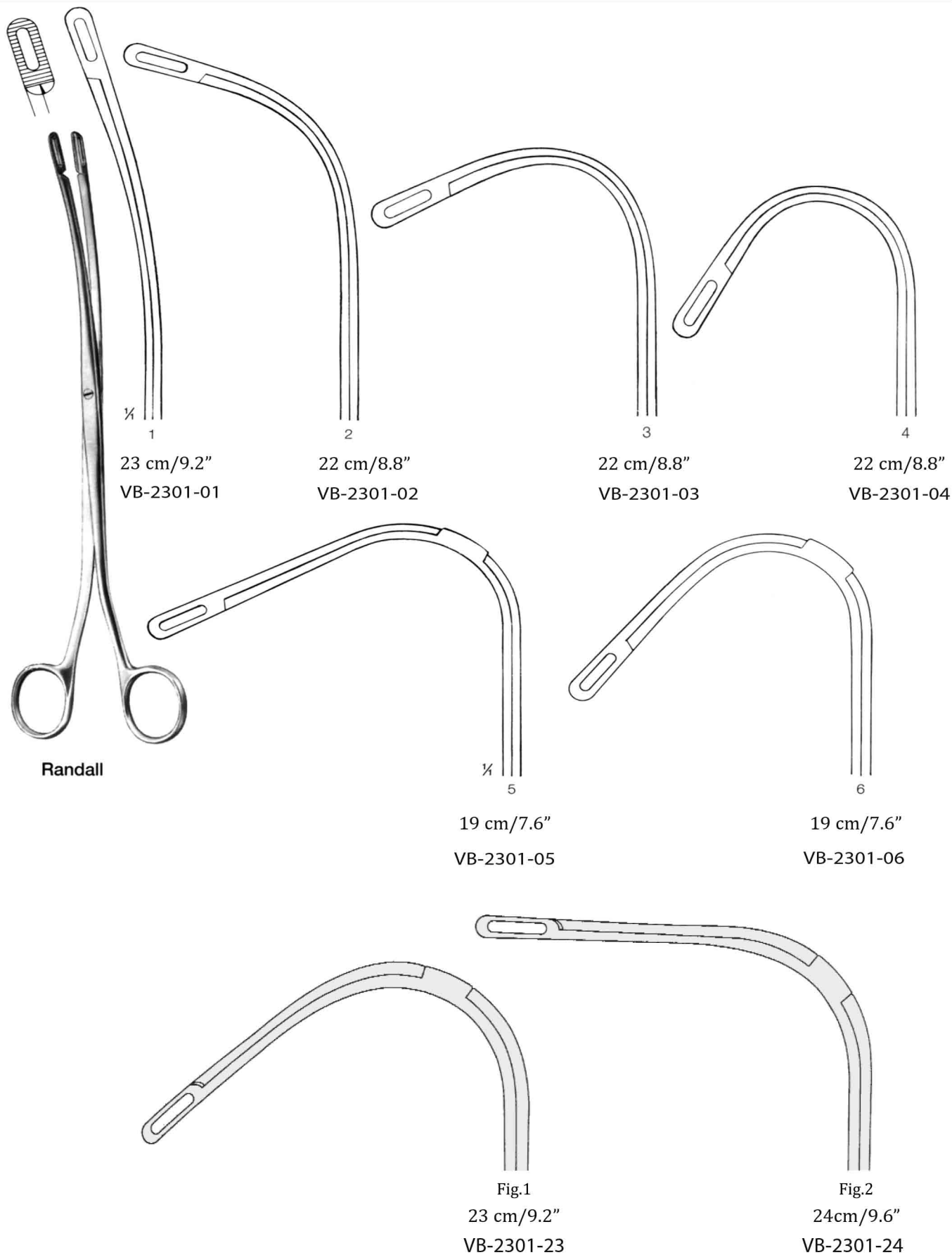

Children Kidney Stone Forceps

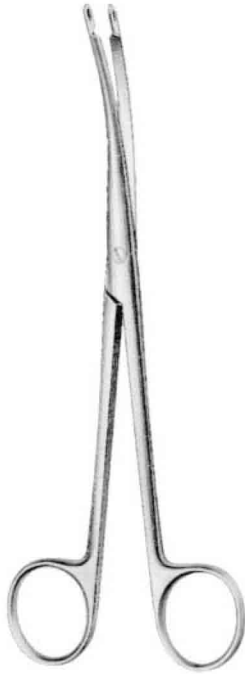

Heiming

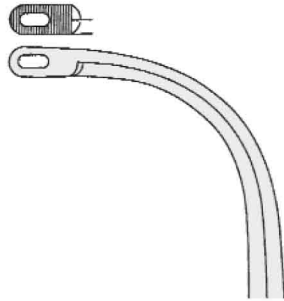

Fig.1

17 cm/6.8"

VB-2311-16

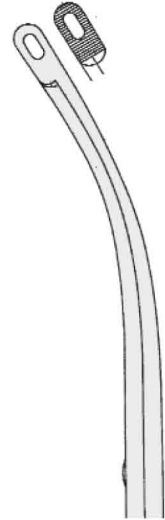

Fig.2

17 cm/6.8"

VB-2311-17

Nephrostomy Forceps



Elsaesser

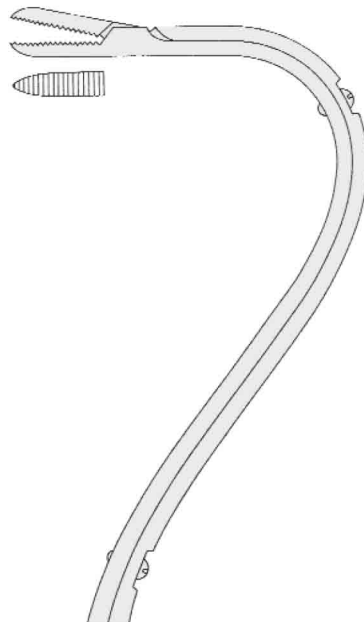

Fig.1

21 cm/8.4"

VB-2305-01

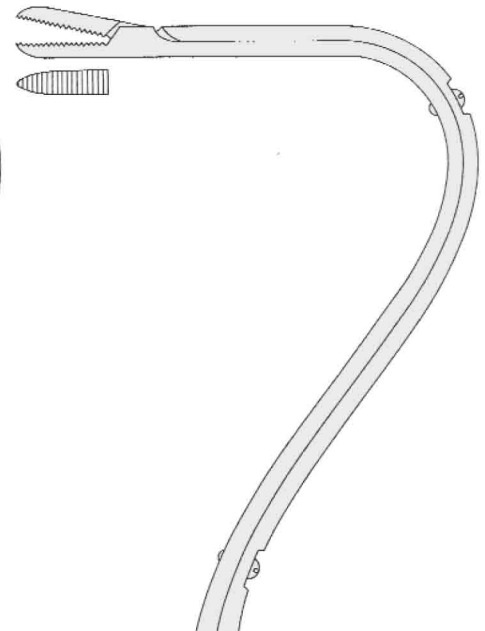

Fig.2

21 cm/8.4"

VB-2305-02

